

Audio  Authority®

***Series 1500™  
Intercom Systems***



***Installer's Reference Guide***

**For Firmware Version 4.0**

# Contents

Introducing Series 1500™ Intercom Systems . . . . .	3
Series 1500 System Components . . . . .	3
2x4 Audio Installation. . . . .	4
2x4 Audio/Video Installation . . . . .	5
Installing Model 1500AH . . . . .	6
Installing a 1509SD Hub . . . . .	7
Installing a 1510 Hub (1511, 1512, 1513 similar) . . . . .	7
Installing Model 1520 Lane Stations . . . . .	8
Using Third Party Traffic Sensors . . . . .	9
Program Audio/Video Connection . . . . .	9
Operation. . . . .	10
Audio or AV Hub Model 1510 . . . . .	12
Hub Configurations and Capacity . . . . .	13
Common Issues . . . . .	14
Testing the Installation . . . . .	14
Troubleshooting Tips . . . . .	14
Using the 1550 Field Setup Tool . . . . .	15
System Calibration and Setup . . . . .	15
Power User Tips . . . . .	15
Setup Menu Map. . . . .	15
Definitions . . . . .	16
1550 Configuration Example . . . . .	17
SD Card Notes . . . . .	18
Firmware Upgrade Instructions . . . . .	18

## WARNINGS

- Read these instructions before installing or using this product.
- To reduce the risk of fire or electric shock, do not expose this unit to rain or moisture.
- This product must be installed by qualified personnel.
- Do not open the cover—there are no user-serviceable parts inside.
- Do not expose this unit to excessive heat.
- Install only in dry, indoor locations.
- Clean the unit only with a dry or slightly dampened soft cloth.

## LIABILITY STATEMENT

Every effort has been made to ensure that our products are free of defects. Audio Authority cannot be held liable for the use of this hardware or any direct or indirect consequential damages arising from its use. It is the responsibility of the user of the hardware to check that it is suitable for his/her requirements and that it is installed correctly. All rights are reserved. No parts of this manual may be reproduced or transmitted by any form or means electronic or mechanical, including photocopying, recording or by any information storage or retrieval system without the written consent of the publisher.

Audio Authority reserves the right to revise any of its hardware and software following its policy to modify and/or improve its products where necessary or desirable.

Audio Authority and the Double-A Symbol are registered trademarks of Audio Authority Corp. Copyright June, 2007. All third party trademarks and copyrights are recognized.



# Installer's Reference Guide

## Introducing Series 1500™ Intercom Systems

Series 1500™ Intercom systems enable clear two-way communications in retail service businesses. Two-way video is integrated with high-performance audio to provide a complete intercommunication solution over a single Category 5e or 6 UTP cable. The versatile Model 1500A or 1500AH Counter Station can access up to 16 lanes. Model 1520 Lane Stations can be connected directly to a Counter Station in a one-on-one system, or multiple Counter Stations and Lane Stations can be networked using an Audio Authority Intercom hub.

Model 1509SD audio hub is perfect for two-on-four audio systems, while 1510 series modular hubs can support up to 8 Counter Stations on 16 lanes. A 1510 series hub is required for multi-lane video systems (see examples). One-way or two-way video is easily added by installing a Model 1501A (inbound only) or 1502A (two-way) Counter Video Add-on.

### Special Tools and Supplies

- Cat 5 network cable tester
- RJ-45 plug crimping tool (Audio Authority recommends EZ-RJ Pro crimp tool)
- Category 5e or 6 UTP cable and RJ-45 terminations (Audio Authority recommends EZ-RJ-45 connectors)
- 18mm flare nut wrench for gooseneck mic installation
- Model 1550 Field Setup LCD Display Tool

### Series 1500 System Components

Counter Station (audio)	1500A	Complete A/V Station	1522
Counter video add-on	1501A	Customer video add-on	1523
Counter video add-on	1502A	Customer video add-on	1524
Wall mount counter video add-on	1501W	Telephone Interface	1533
Wall mount counter video add-on	1502W	Surface-mount handset	1540
2-way video adapter	1504	Flush-mount handset	1541
2-on-4 audio hub	1509SD	Wireless headset	1542
4-on-4 audio/video hub	1510*	Traffic sensor	1547
4-on-8 audio/video hub	1511*	Headset switch	1548
8-on-12 audio/video hub	1512*	Field setup LCD	1550
8-on-16 audio/video hub	1513*	Universal power supply	571-013
4-counter plug-in card	1515	5 Amp power supply	805-028
4-lane plug-in card	1516	Gooseneck microphone	631-026
System plug-in card	1517SD	External microphone kit	631-029
Lane Station	1520	External 3" speaker	631-030

\*See page 11 for hub configurations

## 1x1 Installation

The simplest system configuration involves only one counter station connected directly to one lane station (no hub). This configuration can be audio-only or audio/video. Run a length of Cat 5 cable from the counter location to the lane location; the cable can be up to 1,000 feet long. See "Installing Components" for detailed instructions.

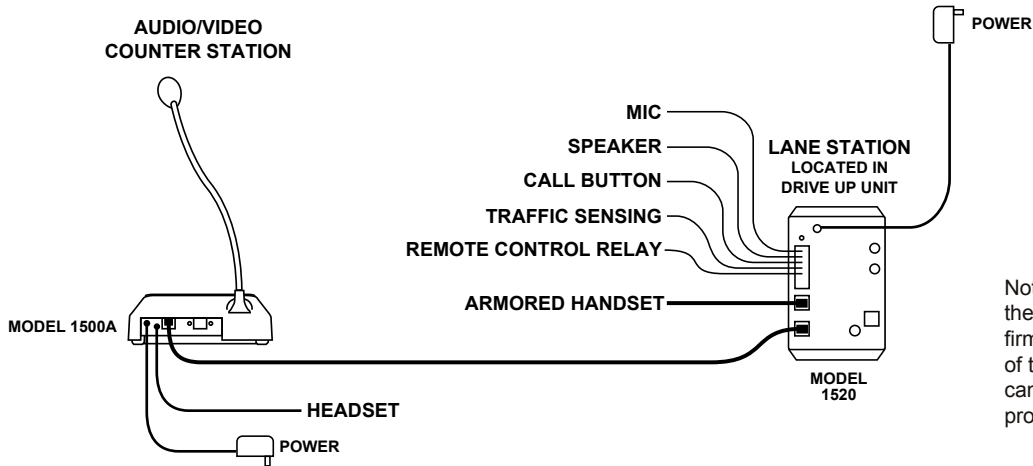

Note: In systems without a hub, there is no way to upgrade firmware or access some features of the 1550 setup tool. A hub can be temporarily connected to program all functions using a 1550.

## 2x4 Audio Installation

The Model 1509SD Audio Hub allows one or two Model 1500A Audio Counter Stations to serve up to four 1520 Lane Stations. **1509SD Hub configurations must be audio-only.** Run a length of Cat 5 cable from each Counter Station to the Hub. Run a length of Cat 5 cable from the Hub to each Lane Station. The total cable length from Counter Station to Lane Station can be up to 1,000 feet. See "Installing Components" for detailed instructions.

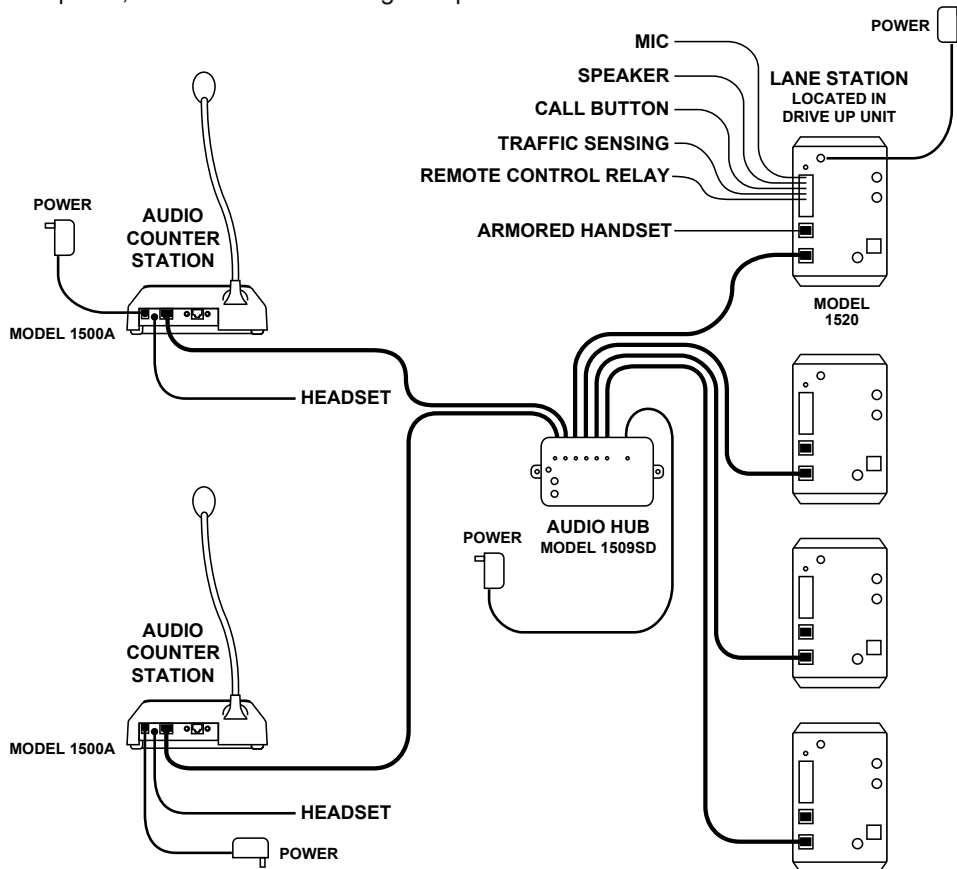

## 2x4 Audio/Video Installation

The Audio/Video Hub configurations allow from one to as many as eight Counter Stations to serve up to 16 Lane Stations. **These configurations (1510, 1511, 1512 and 1513) may be audio-only or audio/video.** Run a length of Cat 5 cable from each Counter Station to the Hub. Run a length of Cat 5 cable from the Hub to each Lane Station. The total cable length from Counter Station to Lane Station can be up to 1,000 feet. See "Installing Components" for detailed instructions.

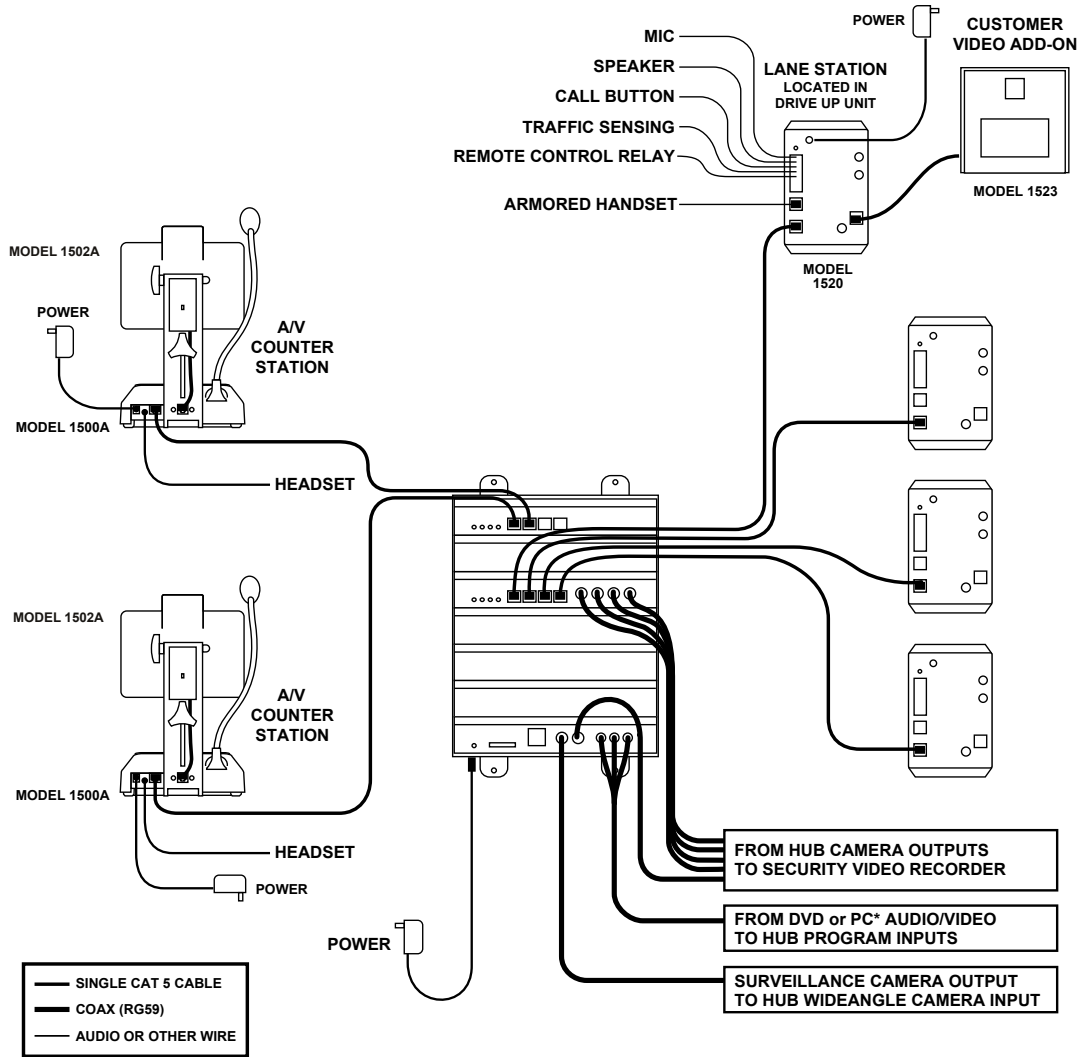

Illustration: Two Counter Stations serve Four Lane Stations. Counter Stations and Lane Stations may have video capability, or audio-only. One Lane Station is shown with a Model 1523 Video Add-On; alternatively, any 1520 may be connected to existing camera and video display.

If desired, any 1520 could be replaced by a 1522 Customer Video Station, which has all the capability and connections of a 1520 plus a camera, video display and call button mounted in one enclosure.

\* PC video output signals may need to be modified for viewing on intercom video displays. See page 9 for details.

## Installing 1500A Counter Stations

1. Unpack each Model 1500A Counter Station and, if applicable, install a 1501A or 1502A Video Display. Plug the Cat 5 video cable into the matching port on the 1500A.
2. Attach the field-replaceable microphone, tightening the nut securely with a 18mm flare nut wrench, and tuck its rubber boot firmly into place.
3. Plug the Cat 5 cable from the hub into the Hub port of each 1500A and connect the power supply to the Power jack. See page 9 for Cat 5 cable fabrication.
4. Install the desired keyboard inlays into the Model 1500A. On initial power-up, the hub sets the default key layout automatically according to the number of connected Counter and Lane Stations (see examples below). You can choose to color-code by the carrier color or label the keys numerically. Place blank, black chips in all non-active positions. Save the unused key chips on the premises for future changes or expansion.

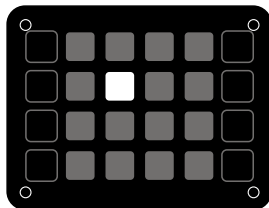
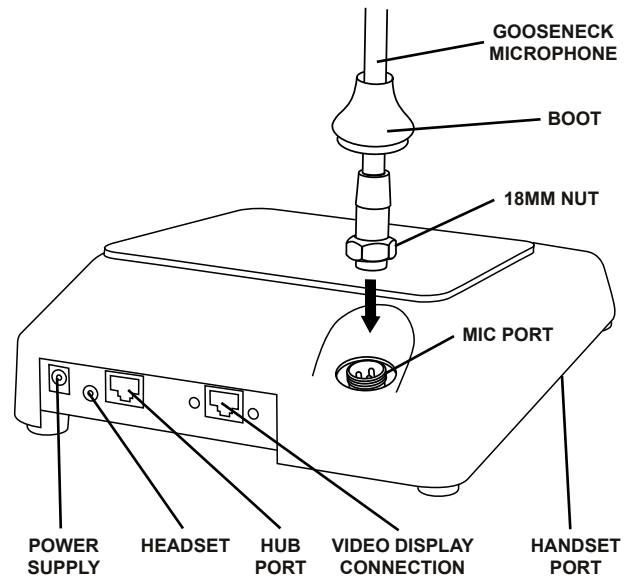

Single Lane (1x1) Default

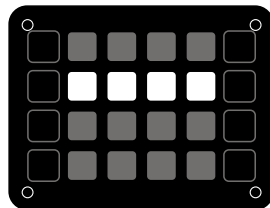

1509 or 1510 Default

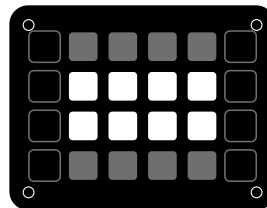

1511 Default

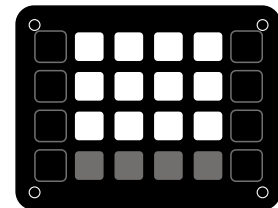

1512 Default

Illustration: Default key assignments for various lane configurations. Key assignments may be changed from default by connecting a 1550 Field Setup Tool and accessing "teller parameters" and "key assignment." See page. 15.

## Installing Model 1500AH

1500AH Counter Stations ship with a handset cradle attached. Install them the same as a 1500A but connect the included handset to the handset port on the underside of the Counter Station as shown. Adjust handset volume using the 1550 field setup tool, then, if more adjustment is desired, use the two knobs on the bottom of the 1500AH as shown.

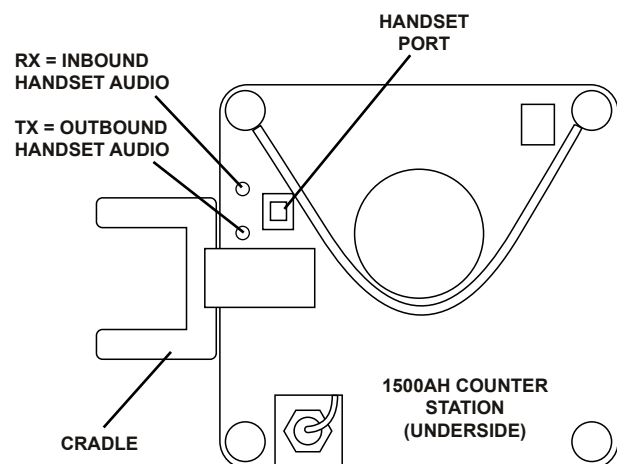

## Installing a 1509SD Hub

The Model 1509SD is a compact audio hub with a maximum capacity of two Counter Stations serving four Lane Stations.

1. Position and install the Hub under the counter or in a secure indoor location such as a telephone closet. Ground the hub to a nearby electrical device cover using the green grounding wire attached to the hub.
2. Run a length of Cat 5 cable from each counter and lane station to the hub. Observe the wiring guide on page 9, and use a cable tester to verify the terminations.
3. If desired, connect an audio source to Program Audio jacks, and adjust volume level during system testing. See page 9 for more on program audio.

Illustration: Shown is Model 1509SD Audio Intercom Hub. Minimum connections are shown for a 1 on 1 system.

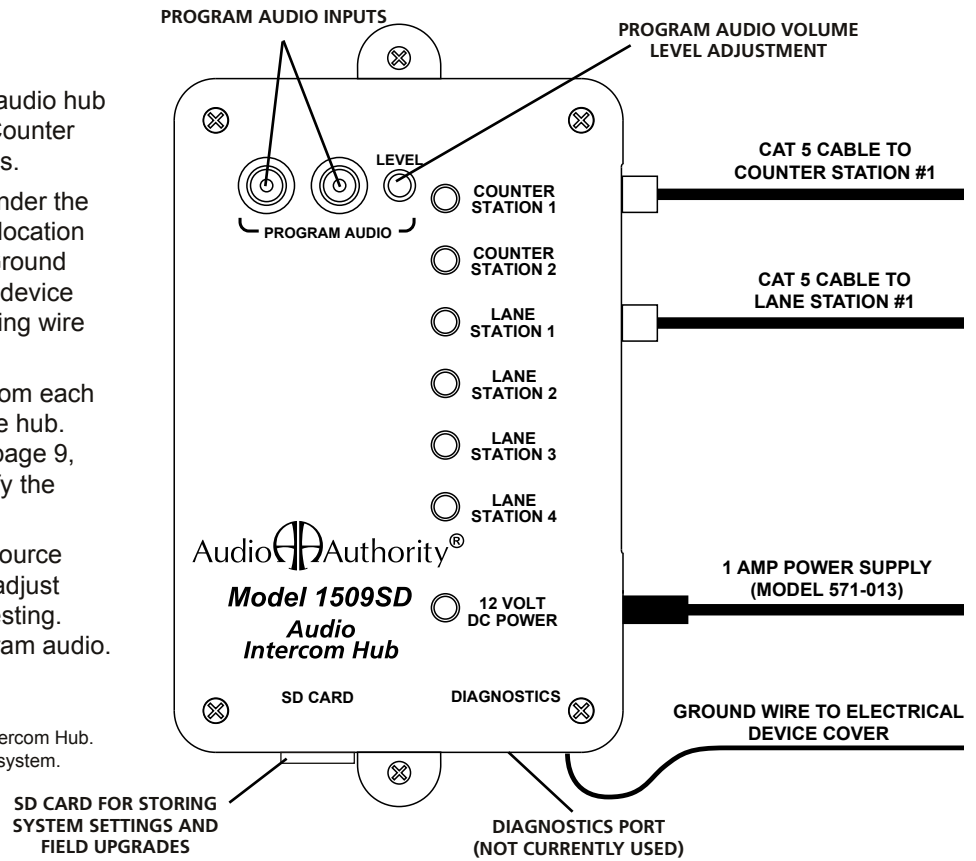

## Installing a 1510 Hub (1511, 1512, 1513 similar)

1. Position and install the Hub under the counter or in a secure indoor location such as a telephone closet. Ground the hub to a nearby electrical device cover using the green grounding wire attached to the hub.
2. If the installation requires additional capacity, install a Counter Card or Lane Card(s) as needed (see page 13).
3. Run a length of Cat 5 cable from each counter and lane station to the hub. Observe the cable fabrication guide on page 9, and use a cable tester to verify the terminations.
4. Connect other equipment as needed. See page 9 for more on program audio.

Illustration: Model 1510, the minimum capacity A/V Hub configuration. Minimum connections for Audio/Video Hubs are shown. For more configurations, system card functions, and other connections, see page 12 and 13.

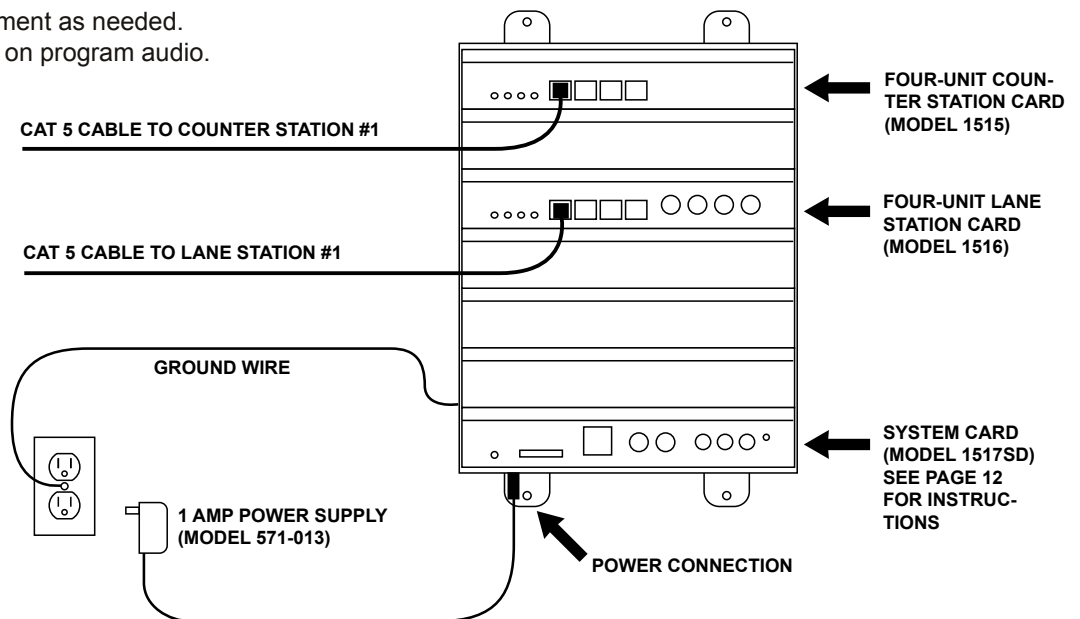

# Installing Model 1520 Lane Stations

Lane Stations may be placed at the customer end of a drive-up or walk-up intercom system. The Model 1520 is the basic Lane Station unit for installations where the microphone, speaker (plus video screen and camera, if used) are mounted separately. The Model 1522 is a Video Lane Station, including all of the features of the 1520 plus microphone, speaker, camera and video screen mounted inside one enclosure. The Model 1523 Video Add-on must be used with a 1520, and contains only the camera and video screen.

1. Install the Model 1520 Lane Station in each deal drawer or pneumatic unit on the customer end, using the screws provided. If AC power is not available at the customer end, see Step 5.
2. Install the lane microphones and speakers if they are not already installed. Mount the speakers in the grilles provided in the drive-up units. Peel the backing from the microphone shrouds and adhere them directly centered over a 1/8" hole drilled in the faces of the customer units. At each station, place the microphone and speaker as far apart as practical, while centering the microphone to receive customer speech. Install Teller Call push-button switches, if needed.
3. Connect the Microphones, Speakers and Teller Call switches to the 1520 terminal blocks. Strip all wires **1/4" long**. If pneumatic blower muting is desired, connect the **DRY** blower contacts to the corresponding points on the terminal blocks, using small (22-18 AWG) wire. If traffic sensing devices or remote-controlled security doors are in use, connect them as indicated.
4. At each lane where video is in use, connect a Model 1523 Video Add-on to the Video port on the 1520 or connect standard 75-ohm NTSC cameras and monitors to the 1520 video jacks. Plug power supplies into the Power jacks.
5. Plug the lane power supplies into a source of 100-240 volts AC. An adapter cable is provided with the 1520 to allow power to be drawn from a terminal block in a pneumatic unit. If AC power is not available on the customer end, a power supply may be located indoors and its output leads extended using a suitable gauge of wire as shown below. To power multiple lane units from a single power supply source, contact Audio Authority Technical Support at 800-322-8346.

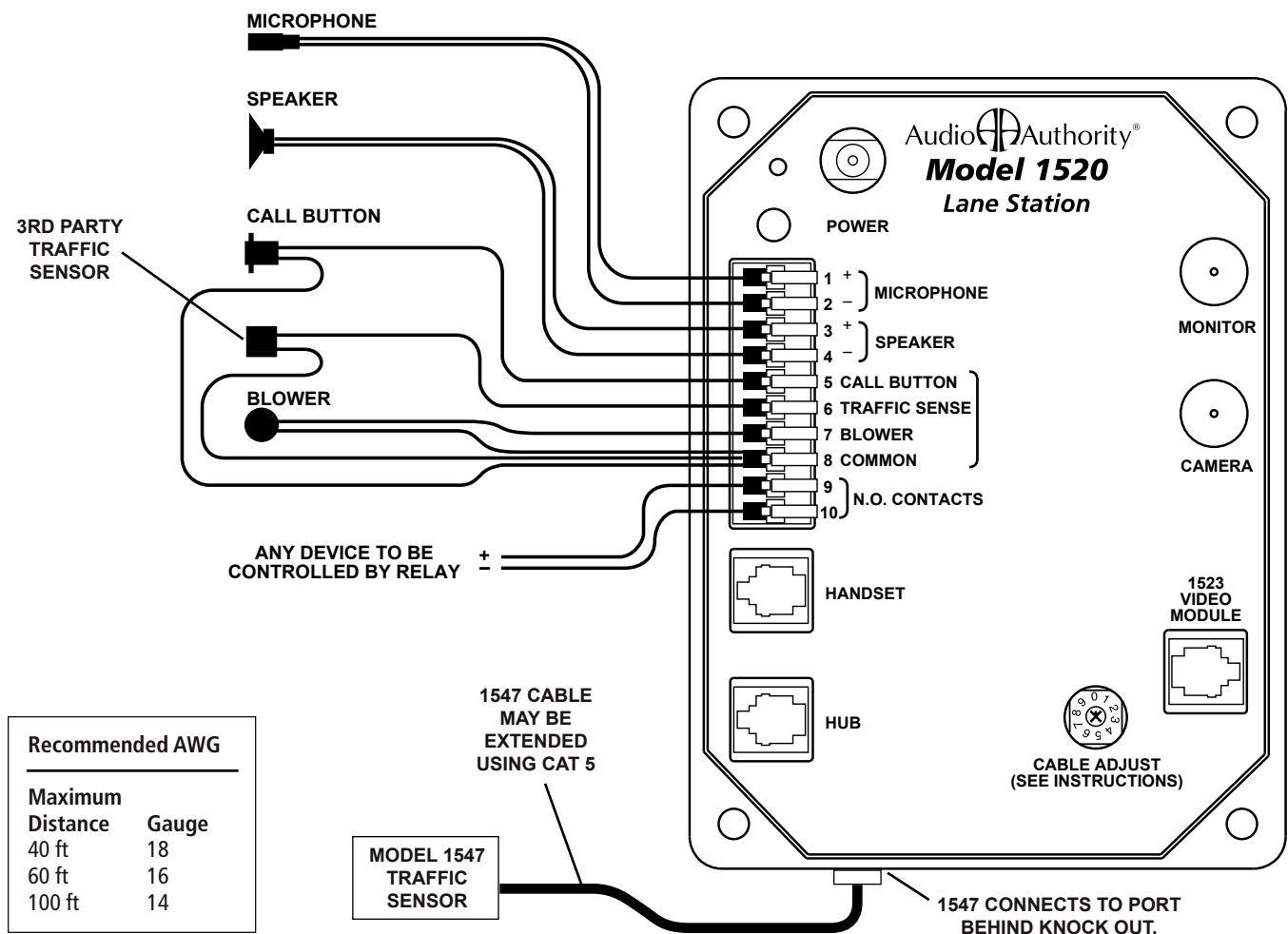

## Using Cable Adjust for Long Cat 5 Cable Runs

For a Cat 5 cable run with total length over 100 feet, use the following guidelines: Set cable length on the receiving end of the cable run in increments of 100 feet (1 = 100 to 199 feet, 2 = 200 to 299, etc.). For 1-way video set only the length control on the 1501. For 2-way video set the length controls on both the 1520 and 1502.

### Cat 5 Cable Fabrication

Cat 5e or Cat 6 is UTP (Unshielded Twisted Pair) cable that can be used to connect Series 1500 components. Terminate the ends of each Cat 5e/6 cable with RJ-45 modular plugs using the EIA 568B pinout (paired 1-2, 3-6, 4-5, and 7-8). Pre-made network cables may also be used for shorter runs. **TEST** all cables (including pre-made) with a network cable tester.

RJ-45 plug with pins facing up and clip facing away. Pin 1

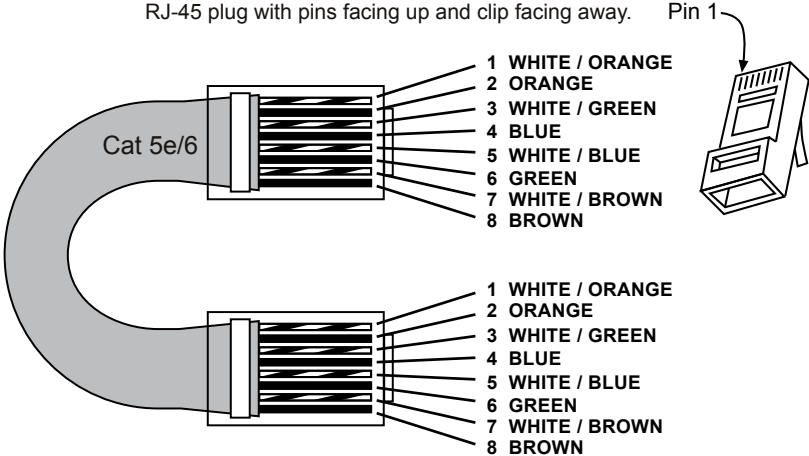

CABLES ARE WIRED THE SAME ON BOTH ENDS (NOT CROSSED OVER).

## Using Traffic Sensors

The 1520 Lane Station provides a connection for Audio Authority's Model 1547 traffic sensor on the bottom edge of the case (see illustration on page 8). When a vehicle triggers the 1547, the Counter Station generates a call tone for the corresponding lane to alert the operator. The call tone for the traffic sensor can be a distinct ring tone from the call button at the same lane. To extend a traffic sensor, use an in-line coupler and a length of Cat 5 cable.

Alternatively, a third party traffic sensor may be used by connecting it to the TRAFFIC SENSE terminal and COMMON terminal as shown on page 8.

## Program Audio/Video Connection

If audio or video program content will be playing at the customer positions when lane stations are on HOLD or idle, plug the source player or PC into the Program Input ports on the 1509SD or 1510 series hub. Program audio level may be manually adjusted at the hub. Any lane's program audio may be turned off during idle periods (still heard while on HOLD) using the 1550 Program Audio Abate setting (see page 16). If the program video source is a PC, either a composite video card or external converter is required. Audio Authority Model 1361 is an ideal adapter to convert VGA to composite video.

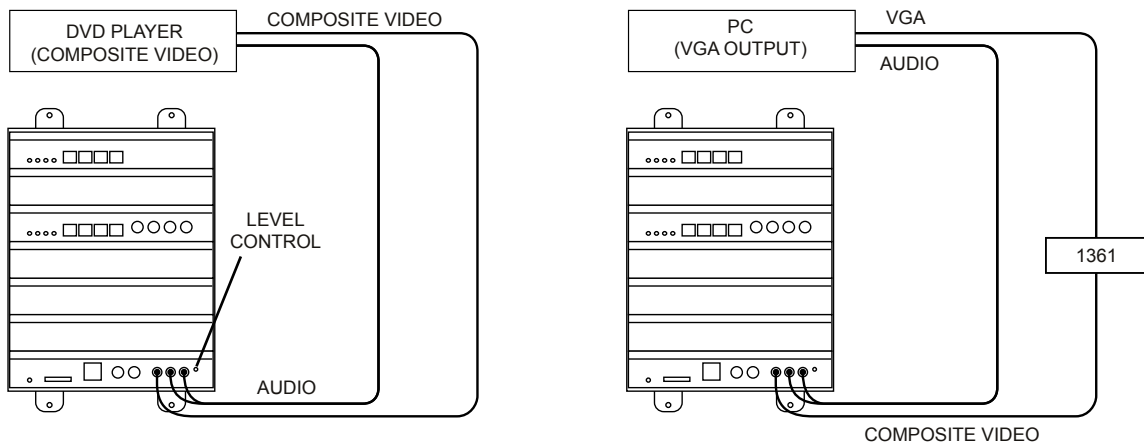

## Operation

The Series 1500 Intercom is operated via touch-sensitive keys on Model 1500A Counter Station keypads, shown below. Tasks such as answering a customer call, ending a call, and putting a customer on HOLD are shown on the Operator Guide (page 11) which should be kept near the Counter Station for reference.

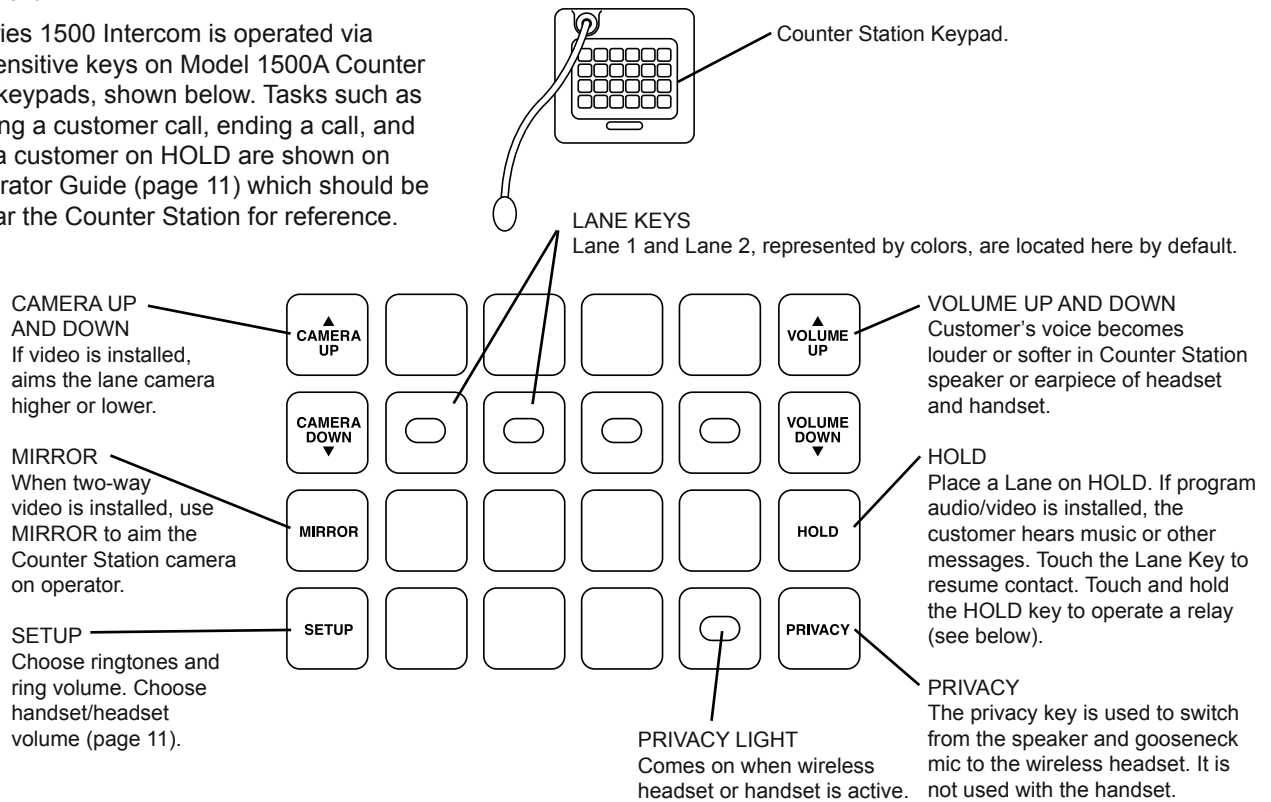

## Operating Remote Devices

The 1520 can be wired to operate a latch or door in a remote location via the 1500A keypad (see page 8 for relay connection details). The system can be set up (using the 1550) to be operated in two different ways; consult your technical support provider for details.

- Option 1: Any time the lane is selected the remote device is active (e.g. a door opens).
- Option 2: When a lane is active, the operator touches and holds the HOLD key to activate the device (e.g. hold the door open). The HOLD key operates normally when touched briefly.

## Using a Wireless Headset or Handset

The 1500A and 1500AH switches between the built-in speaker and gooseneck microphone, the 1500AH handset, and an optional wireless headset. Some examples of using these communication methods are listed below. Always deactivate the wireless headset between customer interactions to increase battery life.

### Answering a Call

- Speaker/gooseneck mic: Touch the rapidly flashing lane key.
- Handset: Pick up the handset. Touch the rapidly flashing key.
- Wireless headset: Activate the headset, touch PRIVACY and select the flashing lane. If the headset is the preferred method, leave PRIVACY on.

### Putting a Call on HOLD

- Speaker/gooseneck mic: Touch HOLD.
- Handset: Touch HOLD, then hang up the handset.
- Wireless headset: Touch HOLD.

### Picking Up a Call from HOLD

- Speaker/gooseneck mic: Touch the blinking lane key.
- Handset: Touch the blinking lane key and pick up the handset.
- Wireless headset: If PRIVACY is already on, activate the headset and select the blinking lane key.

# OPERATOR GUIDE

## Model 1500A Intercom Counter Station

### Operation Tips

- Speak naturally into the microphone at a distance of about two inches
- Touch keys with the pad of your finger
- Press MIRROR to view yourself (2-way video only) – to aim camera, adjust display tilt

### Lane Key Indicators

- RED (flashing rapidly) = Customer CALLING for service
- GREEN = Customer in 2-WAY contact with your counter station
- RED = Customer in 2-WAY contact with another counter station
- GREEN (blinking slowly) = Customer placed on HOLD from your counter station
- RED (blinking slowly) = Customer placed on HOLD from another counter station
- GREEN (flashing rapidly) = Monitoring transaction on another counter station (Master Teller)

### Counter Station

- To contact a customer calling . . . . . Touch LANE key
- To place a customer on HOLD . . . . . Touch the HOLD key
- To contact a customer on hold . . . . . Touch the LANE key
- To end contact with customer . . . . . Touch the active LANE key
- To cancel hold and end contact . . . . . Touch the LANE key twice
- To talk over a customer . . . . . Touch and hold the active LANE key
- To adjust incoming volume . . . . . Touch VOLUME UP or VOLUME DOWN key
- To enter/exit PRIVACY (headset) mode . . . . . Touch the PRIVACY key
- To activate remote relay . . . . . See installer or administrator for instructions

### Adjust Counter Station Handset Volume (1500AH)

- In SETUP MODE, touch PRIVACY and press VOLUME UP or DOWN
- If further handset transmit or receive volume adjustment is needed, contact your technical support provider

### Wireless Headset

- To use a wireless headset, touch PRIVACY, activate the headset, and select the flashing lane key
- If the headset is the preferred method, leave privacy on
- To increase headset battery life, deactivate the headset between customer interactions

### Handset

- To answer a call, pick up the handset and touch the rapidly flashing lane key
- To place a customer on hold, touch HOLD
- To speak to a customer on hold, pick up the handset and touch the lane key

### Counter Station Video

- To adjust outside camera on selected lane . . . . Touch CAMERA UP or CAMERA DOWN key
- To view yourself (to aim camera). . . . . Touch MIRROR key (30 second time-out)
- To view outgoing video program . . . . . Hold MIRROR key 3 seconds (no lane selected)
- To pause lane camera scrolling . . . . . Touch HOLD key (no lane selected)
- To view next lane camera . . . . . Touch CAMERA UP key (no lane selected)
- To view previous lane camera . . . . . Touch CAMERA DOWN key (no lane selected)

### Adjust Ringtones and Ringer Volume

- Touch and hold the SETUP key until lights next to CAMERA and VOLUME keys blink
- Touch CAMERA UP and DOWN to select one of 16 ringtones
- Touch VOLUME UP and DOWN to set ringer volume



2048 Mercer Road, Lexington, KY 40511 • 800-322-8346 • 859-233-4599  
Fax: 859-233-4510 • www.audioauthority.com • support@audioauthority.com

752-487  
9/10

# Audio or AV Hub Model 1510

- The Model 1510 is an audio/video Hub with a capacity of up to four Counter Stations serving four Lane Stations. The Hub's capacity can be expanded in the field by adding Counter and/or Lane cards (see page 13).
- System settings can be stored on a standard SD card for security or replication purposes. Firmware upgrades can be downloaded from the Audio Authority website and performed using the SD card when necessary. These operations require a Model 1550 Field Setup Tool and a Counter Station.
- Composite video and stereo analog audio inputs allow multimedia source devices to play advertising content on any lane whenever it is idle. See page 9 for details.
- Direct outputs from wide angle camera (dedicated security camera) and/or lane cameras for surveillance recording. Video is output continuously from each camera connected.

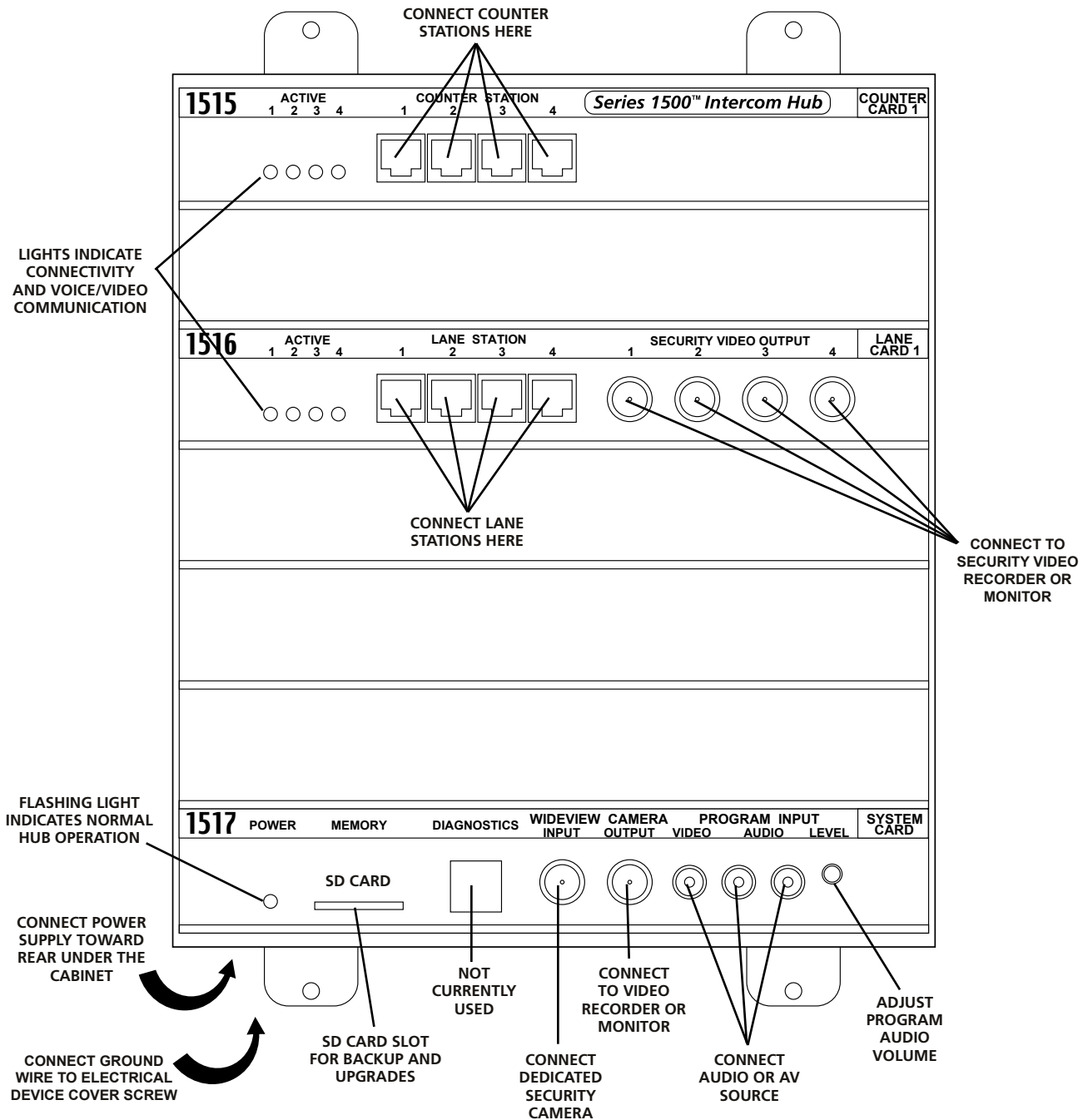

# Hub Configurations and Capacity

Shown below is the Model 1513 Hub, a maximum capacity configuration; all Counter and Lane Card slots are filled. Several other configurations are available; contact Audio Authority® for details, or visit [www.audioauthority.com](http://www.audioauthority.com).

To increase Counter or Lane Station capacity, remove power from the Hub. Remove the blank faceplate from the appropriate card slot(s) and insert the new cards carefully, making sure the connections are firmly seated. Insert the two screws to secure the card, and connect new Lane Stations and/or Counter Stations. Connect power and test the system.

An alternate maximum configuration is possible, in which four Counter Stations serve 20 Lane Stations. If a 4x20 configuration is desired, contact Audio Authority for special instructions.

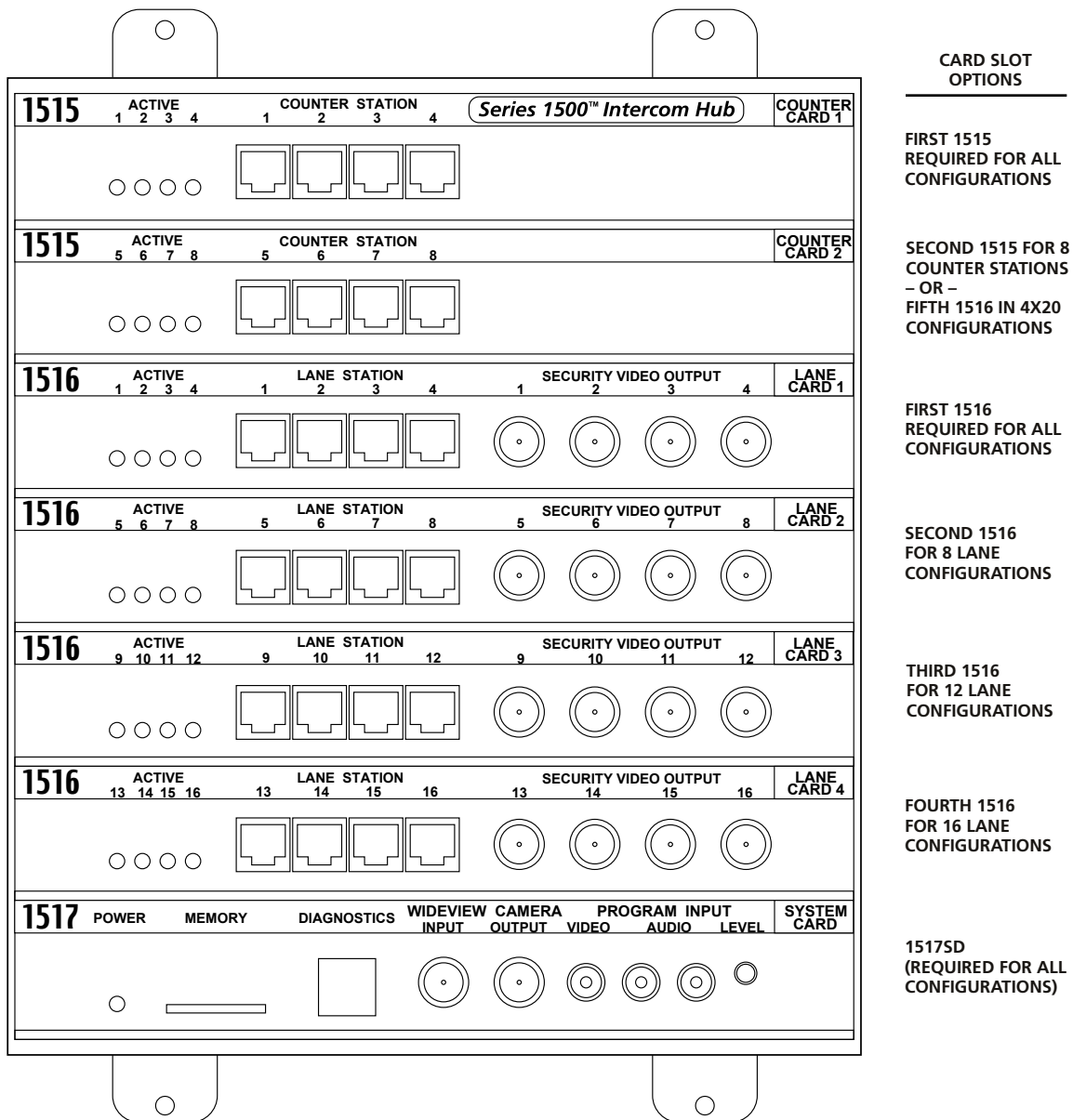

## Testing the Installation

Check the following locations for successful power-up and connectivity, indicated as follows:

- 1500A Counter Station: All LEDs become dark until keys are pressed
- 1509SD Audio Hub: flashing green Power LED, rapidly flashing counter station and lane station LEDs
- 1517SD Hub system card: flashing green LED, rapidly flashing counter station and lane station LEDs
- 1520 Lane Station: rapidly flashing Power LED

Check system operation by selecting each lane and speaking with an assistant at the customer position. Adjust Lane Microphone and Speaker gains using the Model 1550 Field Setup LCD.

## Troubleshooting Tips

- Always test Cat 5 cables with a professional Network Cable Tester – even pre-made cables (see page 9)
- Try connecting a Counter Station directly to a Lane Station to rule out faulty system components
- In case of unexpected performance, restore system defaults to rule out incorrect system parameters

### Common Issues

#### Acoustical Coupling

- Increase separation of lane microphone and speaker
- Isolate lane microphone and speaker with sound-damping barrier (i.e. foam rubber)
- Mount lane speaker and microphone on separate surfaces or adjust their mounting angles
- Adjust inbound, outbound or open loop gain levels

#### Counter Station Lights Remain in 'Burn in' Pattern

- Check Cat 5 cable - consistently use EIA 568B standard cable termination (see page 9)
- Ensure Counter Station is connected to the correct hub port

#### The Deal Drawer Doesn't Sound Right

- Fill hollow cavities in the deal drawer with foam rubber sheets or blocks
- Do not rest Counter Station directly on top surface of deal drawer

#### Repeating Pops in Audio

- Check Cat 5 cables - consistently use EIA 568B standard cable termination (see page 9)

#### No Inbound / Outbound Video or Poor Video Quality

- Check Cat 5 cables - consistently use EIA 568B standard cable termination (see page 9)
- Eliminate long coaxial cable runs between cameras/displays and Lane Station.

#### Lane Keys Don't Respond

- Keys not assigned to Counter Station – reassign keys or restore factory defaults in configuration menu

#### Lane Microphone Doesn't Work

- Microphone must be electret condenser type
- Check microphone polarity

#### Wind Noise

- Can often be eliminated by putting a small plug of 3M Scotchbrite™ in the microphone opening. The Audio Authority lane microphone has a special foam surround; for optimum results, use Audio Authority microphones.

# Using the 1550 Field Setup Tool

## System Calibration and Setup

The Model 1550 is a liquid crystal display that shows the setup menus and settings for Series 1500 Intercom Systems. The entire system can be calibrated from one Counter Station. Connect the 1550 Field Setup Display to the RJ45 jack on the underside of any live Counter Station. (The jack is at an angle.) Upon connection, the 1550 will display "SERIES 1500 EQUIPMENT CALIBRATION PLATFORM".

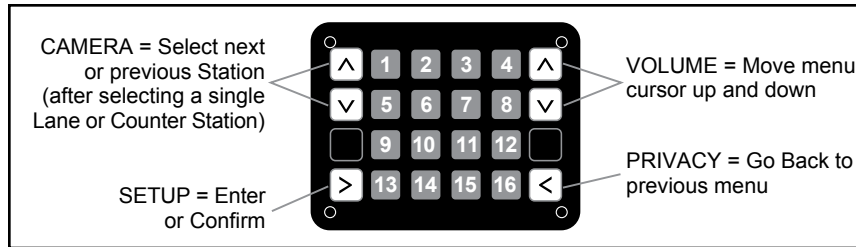
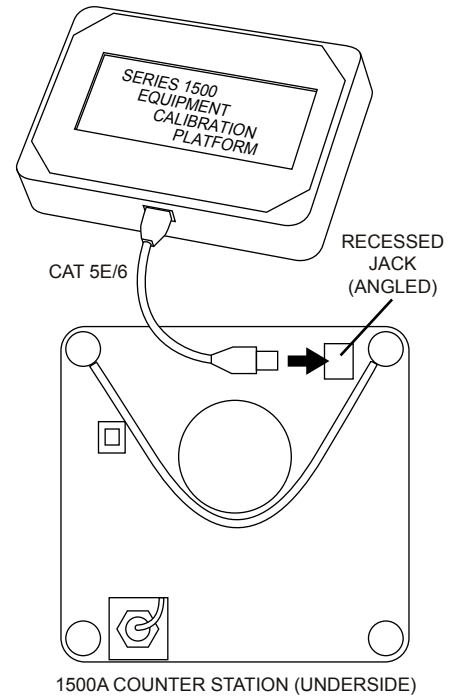

## Basic Setup Procedure

- Hold the SETUP key on the Counter Station for one second to enter Setup Mode. The 1550 displays: "SERIES 1500 EQUIPMENT CALIBRATION PLATFORM".
- To navigate the menus, use the VOLUME UP and VOLUME DOWN keys to move the cursor.
- Touch SETUP to enter a submenu or confirm a selection, and PRIVACY to go back.
- Any changes you make are recorded as you exit each submenu. When you exit Setup Mode, you must choose to either save all changes and exit or exit without saving.
- If you need to re-enter Setup Mode, simply press SETUP for one second.

## Power User Tips

- For faster menu navigation, submenus may be selected by touching the key that is lit RED corresponding to the menu item (see the numbered keys above). For instance, to enter BLOWER MOTOR DELAY, press 1 and then 1.
- To Exit Setup Mode from any menu, hold SETUP for one second and follow the prompts on the 1550.
- After adjusting a Lane Station or Counter Station, use the CAMERA UP or CAMERA DOWN keys to select other stations for adjustment without leaving the submenu.

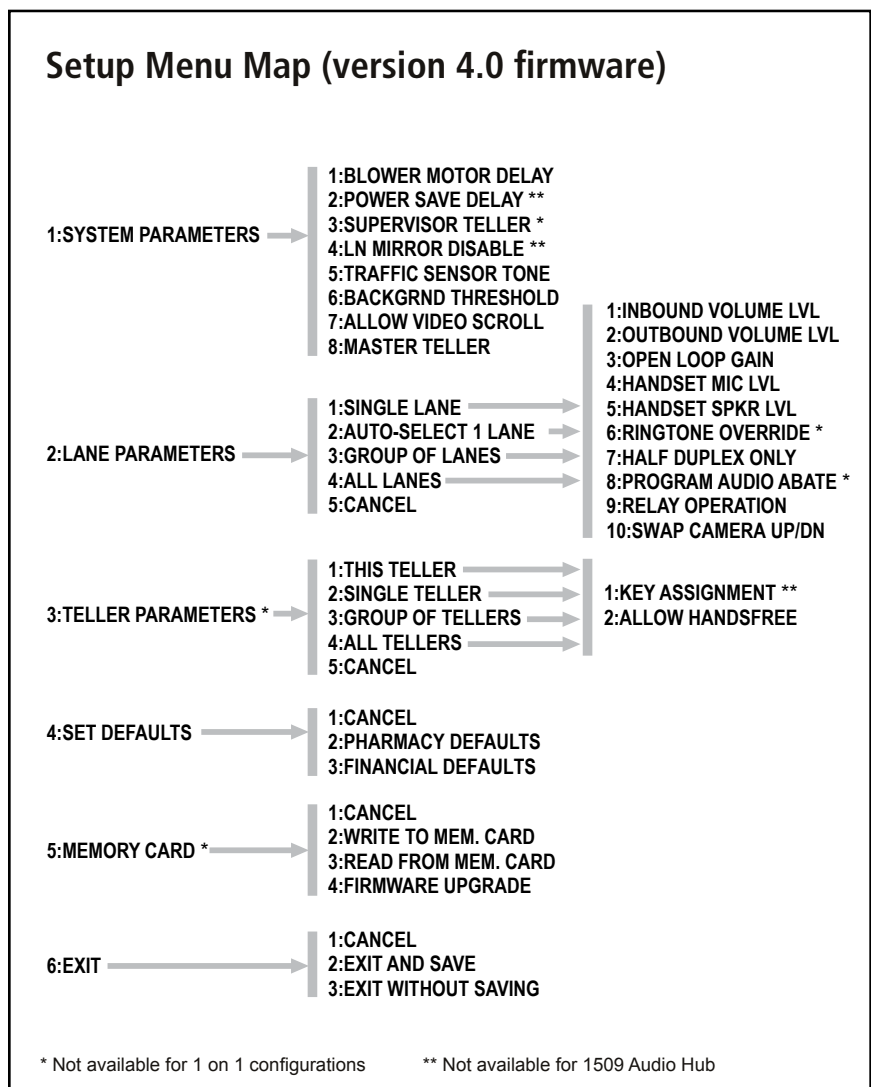

## Definitions

AUTO-SELECT 1 LANE	Allows installer to configure lane audio settings using live audio from the lane. Useful for adjusting inbound and outbound audio levels.
ALLOW HANDSFREE	Allow communication using speaker and gooseneck microphone.
ALLOW VIDEO SCROLL	Inactive Counter Stations view all available cameras in sequence; when video scroll is disabled, inactive Counter Stations see only the wideview camera (if installed).
BACKGRND THRESHOLD	Adjustment for level of background audio rejected by Counter Station microphone. 0 = no rejection.
BLOWER MOTOR DELAY	If enabled, the period between disengagement of blower and microphone audio un-mute.
FIRMWARE UPGRADE	This menu allows the firmware of system components to be upgraded.
HANDSET MIC LVL	Inbound handset volume level adjustment.
HANDSET SPKR LVL	Outbound handset volume level adjustment.
HALF DUPLEX ONLY	Enables 'push-to-talk' operation.
INBOUND VOLUME LVL	Inbound volume level adjustment.
KEY ASSIGNMENT	This menu enables lane selection keys to be redefined in any configuration desired. First select the lane number to be assigned using the VOLUME keys. Then touch the key to be assigned to that lane. If the desired key is already assigned, touch it twice. For 20 lane systems use "Page Mode". Page Mode allows the user to flip between two "pages" of keys. The first page contains lane 1-10, the second 11-20. To enter or exit Page Mode, touch the HOLD key while in KEY ASSIGNMENT.
LANE MIRROR DISABLE	OFF = idle Lane Stations display their own camera output. ON = idle Lane Stations DO NOT display their own camera output.
MASTER TELLER	Enables one Counter Station to monitor conversations conducted on all other Counter Stations.
OUTBOUND VOLUME LVL	Outbound volume level adjustment.
OPEN LOOP GAIN	Adjustment for adapting to different acoustic environments. Lower this setting for Lane Station acoustical environments with too much microphone and speaker coupling. Increase this setting to hear more of the customer while operator is talking.
PGM AUDIO ABATE	ON = Program Audio heard ONLY when lane is <i>on hold</i> . OFF = Program Audio heard when lane is <i>idle</i> OR <i>on hold</i> .
PHARMACY SETTINGS	See the Model 1533 Telephone Intercom Interface Manual for details.
POWER SAVE DELAY	If enabled, the length of time the system must be idle before entering Power Save (LCD sleep). This feature only applies to lane monitors, not Counter Station monitors.
READ FROM MEM. CARD	System settings are restored from hub memory card.
RELAY OPERATION	Allows configuration of Lane Station relay contacts (Model 1520 terminal block pos. 9 & 10). The contacts can be set to close using the HOLD key, or while the lane is selected. (See Operator Card I for HOLD key operation details.)
RINGTONE OVERRIDE	Press a key to select a unique ringtone for the selected Lane Station(s). 1 = no override (plays the ringtone set by each Counter Station). All other keys represent unique ring tones which override any Counter Station settings.
SINGLE LANE	Allows installer to configure lane audio settings without using live audio from the lane. Useful when lanes are in use or audio is not required for adjustments.

SUPERVISOR TELLER	If enabled, allows one Counter Station to monitor others.
SWAP CAMERA UP/DOWN	Swaps functions of the camera up and down buttons – use with third party camera tilt.
TRAFFIC SENSOR TONE	Press a key to select a unique ringtone for all traffic sensor events. 0 = no ringtone, 1 = use Lane Station Ringtone Override setting.
WRITE TO MEM. CARD	System settings are saved to hub memory card.

## 1550 Configuration Example

To enter the configuration menu, connect a 1550 Field Setup LCD Display to the underside of any 1500A Counter Station, then press and hold the SETUP key for one second.

### 1. Adjust Audio Levels

*Select 2: LANE PARAMETERS – Select 2: AUTO-SELECT 1 LANE – Touch SETUP*

- a. Inbound audio level
  - i. Select 1: INBOUND VOLUME LVL
  - ii. Select exact value (1 – 16) or use VOLUME keys to raise or lower inbound volume
  - iii. Touch PRIVACY key to return
- b. Outbound audio level
  - i. Select 2: OUTBOUND VOLUME LVL
  - ii. Select exact value (1 – 16) or use VOLUME keys to raise or lower outbound volume
  - iii. Touch PRIVACY key to return
- c. Adjust open loop gain
  - i. Select 3: OPEN LOOP GAIN
  - ii. Select exact value (1 – 16) or use VOLUME keys to raise or lower open loop gain
  - iii. Touch PRIVACY key to return
- d. Touch CAMERA UP/DOWN keys at any time to adjust next/previous lane station

### 2. Configure Key Assignment

*Select 3: TELLER PARAMETERS - Select 2: SINGLE TELLER – Touch SETUP – Select 1: KEY ASSIGNMENT*

- a. Use VOLUME keys to select lane to be assigned
- b. Touch any lane key to assign selected lane to that key
- c. If the desired key is already assigned, touch it twice
- d. Touch CAMERA UP to configure next teller station

### 3. Save Settings and Exit Setup

- a. Hold SETUP for one second to jump to EXIT menu at any time
- b. Select 2: EXIT AND SAVE
- c. Touch SETUP, then press SETUP again to confirm

## SD Card Installation Notes

Series 1500 SD cards have two uses: Storing intercom configuration data and upgrading the intercom system firmware.

- Storing the configuration of the intercom system for later retrieval is the primary use for the SD card. This can save time from one installation to the next if the installations are similar. The system settings can also be retrieved from the memory card in case of a system upgrade or replacement.
- To store configuration data on the memory card, insert the card into the hub and perform a WRITE TO MEM.CARD operation in the SETUP menu (see page 15). Then remove the card and store it onsite in a safe, designated location. In the same manner, write the configuration data to an additional SD card if copying the settings to another system is desired.
- To retrieve configuration data from the memory card, insert the card into the hub and perform a READ FROM MEM.CARD operation in the SETUP menu (see page 15).

*NOTE: It is NOT necessary that the SD memory card remain in the hub during normal operation.*

## Firmware Upgrade Instructions (Version 4.0 and later)

The Series 1500 Intercom was designed to be firmware upgraded in the field if necessary. In order to perform a firmware upgrade, download the desired firmware version from [www.audioauthority.com](http://www.audioauthority.com) and copy the file onto any SD card. Note: Series 1500 equipment with firmware prior to version 1.5 may not be upgraded to version 4.0. To upgrade to Version 4.0, the system must have a new 1509SD hub, or a new 1517SD hub card.

Note: Because of the new SD Card data transfer protocol, this upgrade may take 10 minutes or longer. The system cannot be used during this time, so plan for several minutes of down-time to complete the upgrade.

- Insert a version 4.0 Memory Card into the 1509SD or 1517SD Card slot.
- Connect a 1550 Field Setup and Programming Tool to the underside of a Model 1500 Counter Station that has firmware v1.9 or higher.
- Press Setup for 2 seconds
- Press Key 5 (1st button on second row)
- Press Key 4 (last button on top row)
- Press the Mirror key
- Press the Setup key twice

After a successful upgrade, "Firmware upgrade complete" is displayed on the 1550 screen. The menu on the 1550 now shows several new selection options that apply only to the new 1500A, 1500AH, and 1533. Once the upgrade is complete, all indicators on the hub will return to normal operation.

\* 1 on 1 Systems may be upgraded by temporarily inserting a hub into the system.

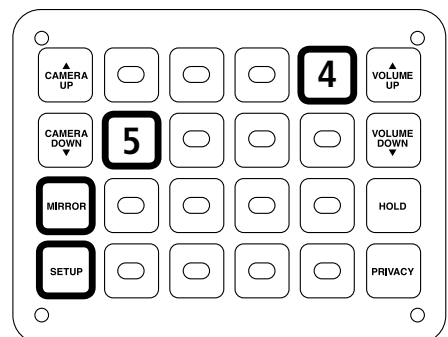





2048 Mercer Rd., Lexington, KY 40511-1071 USA

Phone: 859-233-4599 • 800-322-8346

Web: [www.audioauthority.com](http://www.audioauthority.com)